

MACHINE DESCRIPTION

The drum seeding line LAMBDA65 can reach a production up to 650 trays/hour.

The trays advance one next the other on the trayfiller belt, ensuring the maximum filling uniformity in every cell, also in those along the edge of the tray. The filling can be adjusted with one single handle and enables a variable filling with soft, medium or high density.

The brushing group perfectly cleans the trays from the exceeding soil, which is completely recycled without any wasting.

The driven dibbler ensures a centered positioning in the cell and a perfectly regular shape of the hole.

The seeding group can be equipped with up to 3 seeding drums for multiseeding or chemical grain dispensing, with a perfect singularisation of both small and big seeds.

Changing the seeds or the trays is faster, thanks to the electronic drums, the fast adjustments and the drums changing without any tool.

The drum coverer for vermiculite or other grains performs a great uniformity and enables to choose the working width and the quantity of product distributed, to reduce any wasting.

Each component of the machine is designed and produced to improve the work of operators, in order to reduce the maintenance and speed up the seed's change.

TECHNICAL DATA

HOURLY PRODUCTION (min-max)

TRAYS DIMENSIONS (max)

WEIGHT

VACUUM PUMP

AIR CONSUMPTION (max)

WATER CONSUMPTION to 2 atm (max)

INSTALLED POWER



- 1 Pneumatic tray denester with 2 movements for polystyrene trays.
 - 2 Soil hopper capacity 600 l with agitator.
 - 3 Soil elevator with cups-system width 470 mm with double chain.
 - 4 Trayfiller with linear rotor with 4 blades.
 - 5 Double auger and tray cleaning brush.
 - 6 Recycling hopper for exceeding soil with auger.
 - 7 Driven dibbler with cleaning brush and electronic adjustment.
 - 8 Seeding drum with electronic control, with 20 rows, for better precision with small and big seeds.
 - 9 Air bars with double row of nozzles and seed holding plate with pneumatic vibrator.
 - 10 5,7" colour touch-screen panel.
 - 11 Drum cover for vermiculite, with adjustable speed and dosage, capacity 170 l.
 - 12 Watering unit length 250 mm with 2 drilled bars.
 - 13 Pneumatic balance stacker.
 - 14 Longitudinal tray advancement.
- Electrical adjustment of seeding drum and dibbler working height.
 - Rapid adjustment of tray width with self-centering handles.
 - Available in left and right version.

M.U.	LAMBDA65	LAMBDA65 A	LAMBDA65 E
trays/hour	100-650	100-600	100-600
mm	580x400	750x400	750x500
kg	1480	1480	1480
model	PVA 750	PVA 750	PVA 750
l/min	190	190	190
l/min	20	20	20
kW	9	9	9

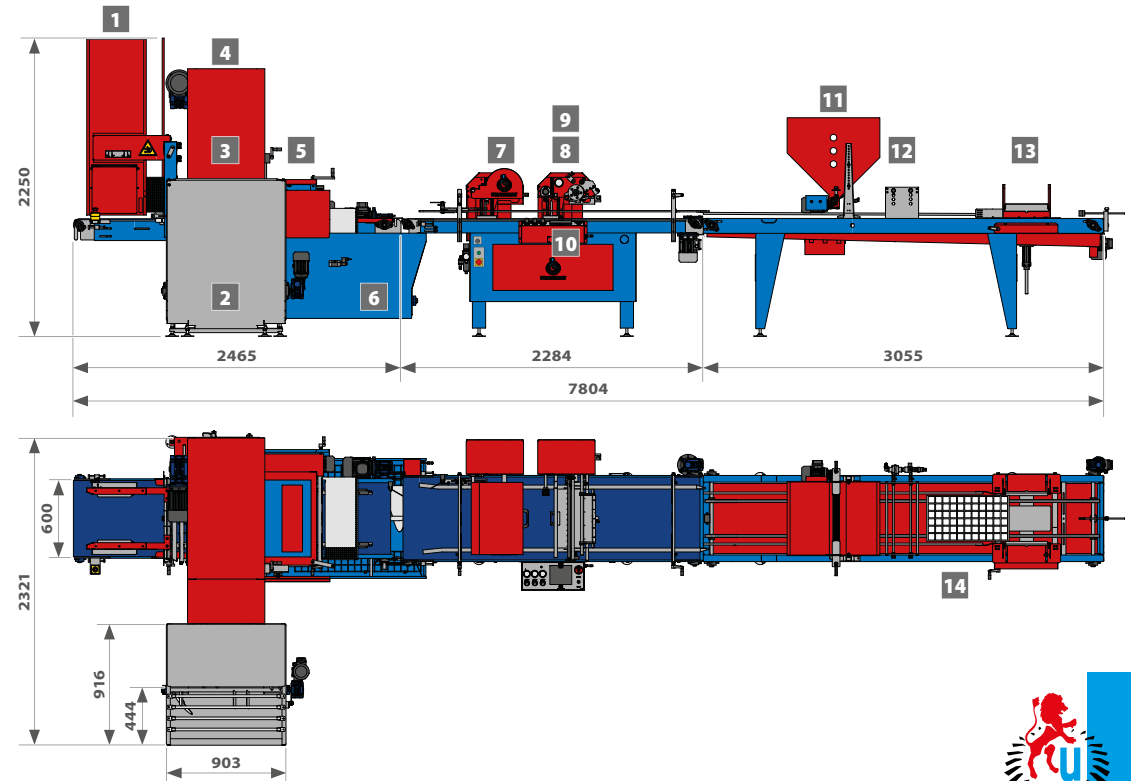



DETAILS

SEEDING



Ergonomic panel for an easy control of all machine's functions.

INCLUDED ON:
ALL SEEDING LINES



Colour touch-screen with intuitive graphic easy to use for the operator.

INCLUDED ON:
ALL SEEDING LINES

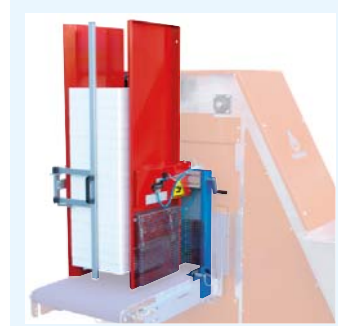

Tray denester **with 2 movements**, adjustable with one single handle.

INCLUDED ON:
ALL SEEDING LINES

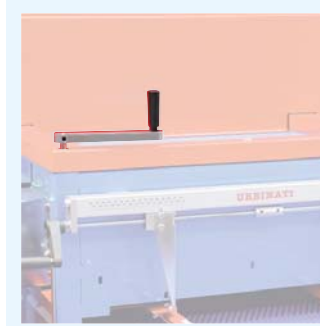

The adjustment of the tray's height, width and soil density is made with **functional handles**.

INCLUDED ON:
ALL SEEDING LINES

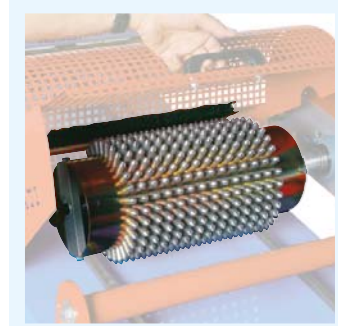

Driven dibbler with cleaning brush.

INCLUDED ON:
SIGMA80, ALFA65, BETA65/65C,
LAMBDA65/65C, YPSILON65/65C



Double blow bar with more holes for the **seeding singulation**.

INCLUDED ON:
SIGMA80, ALFA65, BETA65/65C,
LAMBDA65/65C, YPSILON65/65C



Easy and fast adjustment of seeding system's height and dibbler's depth, thanks to **comfortable handles**.

INCLUDED ON:
SIGMA80, ALFA65, BETA65/65C,
YPSILON65/65C, KAPPA65C



Electric adjustment of the drums' height with touch-screen.

INCLUDED ON:
LAMBDA65/65C



Adjustable speed hammers. The vibration helps placing the seeds in the center of the holes.

INCLUDED ON:
SIGMA80, ALFA65,
BETA65/65C

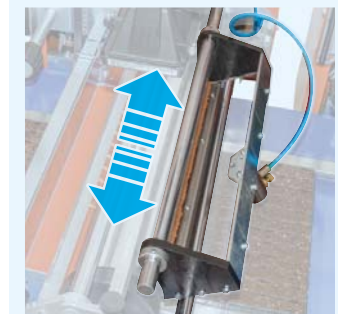

Oscillating seed holding plate to distribute the seeds **uniformly** all over the working width. It enables to work also with a small quantity of seed.

INCLUDED ON:
SIGMA80, ALFA65, BETA65/65C,
LAMBDA65/65C, YPSILON65/65C

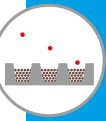

Thanks to the **modularity of the design**, our seeding lines and seeders **share common parts**.
The following pictures show some of the **most significant details**.

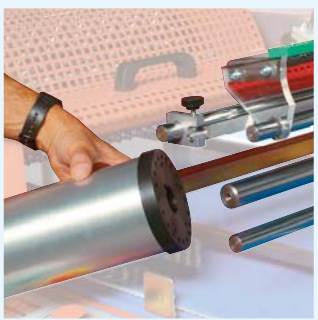

Fast and easy changing of the drum without any tool.

INCLUDED ON:

SIGMA80, ALFA65, BETA65/65C, LAMBDA65/65C, YPSILON65/65C



High-power vacuum pump: enables to use the same drum for the variety sowing of different weight.

INCLUDED ON:

SIGMA80, ALFA65, BETA65/65C, LAMBDA65/65C, YPSILON65/65C

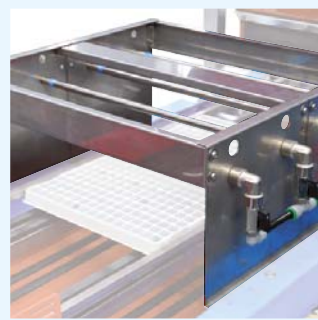

The drilled bar system, produced by CNC machines, makes the **watering uniform**.

INCLUDED ON:

ALL SEEDING LINES

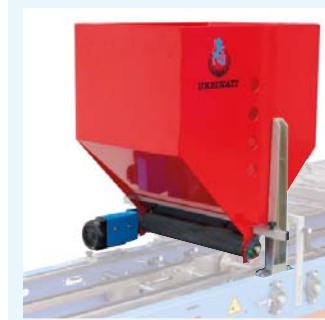

Drum vermiculite coverer: guarantees the best uniformity with all the granulometries.

INCLUDED ON:

ALL SEEDING LINES



Easy and functional **balance stacker**.

INCLUDED ON:

ALL SEEDING LINES



Fast and self-centering system for width adjustment of the trays with handles.

INCLUDED ON:

SIGMA80, ALFA65, BETA65, LAMBDA65, YPSILON65

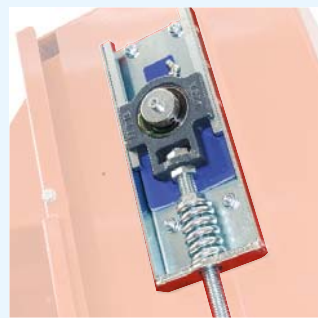

Engineering solutions aimed to reduce and simplify the maintenance. For example, visible bearings lubricator, spring tensioner on chains, etc.

INCLUDED ON:

ALL SEEDING LINES



Strong manufacturing and lasting materials, for example stainless steel and hot galvanizing for parts in contact with soil and water.

INCLUDED ON:

ALL SEEDING LINES



Seeding plate on sliding guides for a **fast change**.

INCLUDED ON:

SEMBLOCK



URBINATI

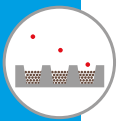

ACCESSORIES

SEEDING

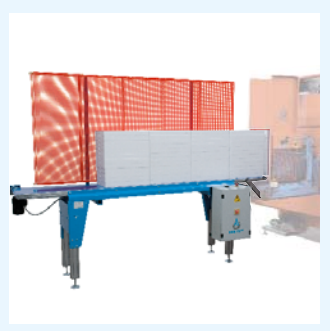

Feeding belt for single trays or empty stacks for denester.

L = 3300/4300/5300/6300 mm.

1

AVAILABLE ON:

ALL SEEDING LINES



Denester for heavy plastic trays at injection in polypropylene PP.

2

AVAILABLE ON:

ALL SEEDING LINES

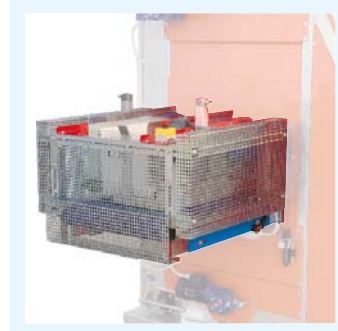

Electropneumatic denester with 3 movements for thermoformed trays (PE - PET).

3

AVAILABLE ON:

ALL SEEDING LINES



Adjustment device for trays with legs.

4

AVAILABLE ON:

ALFA65, BETA65/65C, LAMBDA65/65C, YPSILON65/65C, KAPPA65C

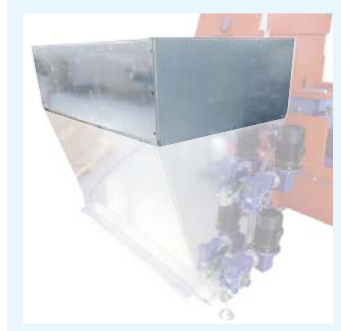

Peat hopper extension of 900 l.

5

AVAILABLE ON:

SIGMA80, ALFA65, BETA65, LAMBDA65, YPSILON65



Flat dibbler for seeding of aromatic plants and multiseeding.

6

AVAILABLE ON:

ALL SEEDING LINES AND SEEDERS with drum seeding system



Oscillating cleaning brush for the dibbler, useful with wet soil.

7

AVAILABLE ON:

SIGMA80, ALFA65, BETA65/65C, SEMBETA65

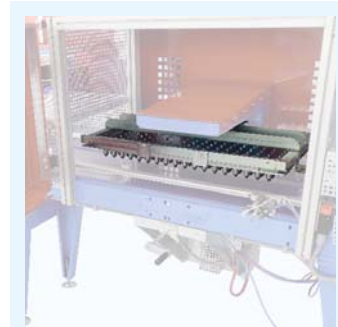

Plate dibbler mod. NI for depth bigger than 20 mm and for seeders assembled with nr. 3 sowing drums.

8

AVAILABLE ON:

LAMBDA65/65C, SEMLAMBDA65



Complete drum seeding kit: it includes one dibbler, one seeding drum and two nozzle bars.

9

AVAILABLE ON:

SIGMA80, ALFA65, BETA65/65C, LAMBDA65/65C, YPSILON65/65C, SEMBETA65, SEMLAMBDA65, SEMYPSILON65



Seeding bar kit: it includes one nozzle bar, one tube descent bar and one dibbler bar.

10

AVAILABLE ON:

KAPPA65C, SEMKAPP65, SEMSF13

These accessories **improve further the performance** and the productivity of our seeding lines and seeders.
Our **engineering dept.** is at your disposal **to suggest the best solutions** for your needs.

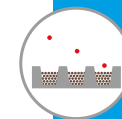

11 Sowing drum with **multi-hole nozzles** for aromatics, microgreens etc.

AVAILABLE ON:

SIGMA80, ALFA65, BETA65/65C, LAMBDA65/65C, YPSILON65/65C, SEMBETA65, SEMLAMBDA65, SEMYPSILON65, SEMBLOCK



12 Seeding drum with **raised nozzles** for difficult seeds, for example tagetes, zinnia, etc.

AVAILABLE ON:

LAMBDA65/65C, YPSILON65/65C, SEMLAMBDA65, SEMYPSILON65



13 **Air bars** with labyrinths suitable to work with **big seeds**.

AVAILABLE ON:

SIGMA80, ALFA65, BETA65/65C, LAMBDA65/65C, YPSILON65/65C, SEMBETA65, SEMLAMBDA65, SEMYPSILON65



14 **Drum for big seeds**, as for ex. acorns.

AVAILABLE ON:

ALFA65, BETA65/65C, SEMBETA65

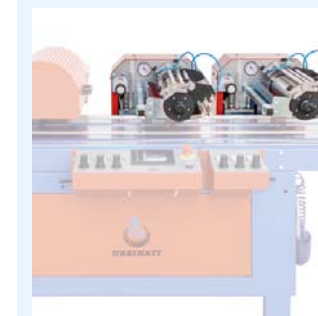

15 **Second/third sowing drum.**

AVAILABLE ON:

Second drum: SIGMA80, ALFA65, BETA65/65C, SEMBETA65
Second/third drum: LAMBDA65/65C, SEMLAMBDA65



16 Belt for the **recycling soil** for trayfiller.

AVAILABLE ON:

BETA65C, LAMBDA65C, YPSILON65C, KAPPA65C



17 **Seed inspection** to easily check the sown trays.

AVAILABLE ON:

ALL SEEDING LINES AND SEEDERS AND *except* SEMSF13



18 **Sand and soil coverer** with brush to clean the trays.

AVAILABLE ON:

ALL SEEDING LINES AND SEEDERS *except* SEMSF13

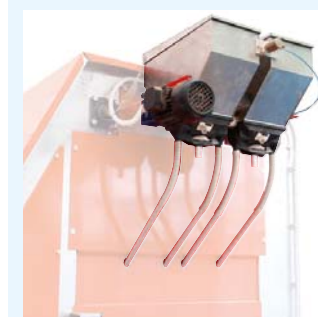

19 **Fertilizer distributor.**

AVAILABLE ON:

SIGMA80, ALFA65, BETA65, LAMBDA65, YPSILON65



20 **Loading and automatic recycling** of vermiculite with hopper capacity 240 l.

AVAILABLE ON:

ALL SEEDING LINES AND SEEDERS *except* SEMSF13





ACCESSORIES

SEEDING



Soil recycle, to recover the exceeding soil. **21**

AVAILABLE ON:

ALL SEEDING LINES AND SEEDERS
except SEMSF13



Triget watering unit: on request as alternative to the watering unit with drilled bars. **22**

AVAILABLE ON:

ALL SEEDING LINES AND SEEDERS
except SEMSF13

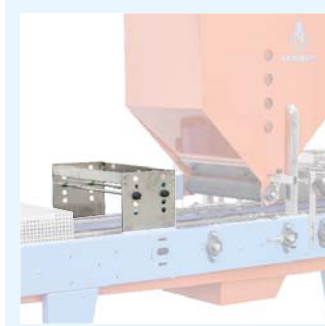

Second water unit with nr. 2 drilled bars: mainly needed to increase the soil watering. **23**

AVAILABLE ON:

ALL SEEDING LINES AND SEEDERS
except SEMSF13



ETC automatic labelling machine: to print and apply labels on the trays coming out from the denester. **24**

AVAILABLE ON:

ALL SEEDING LINES



Black ink jet printer mod. U2011: fixed version for moving trays to write on the long side of the tray. **25**

AVAILABLE ON:

ALL SEEDING LINES AND SEEDERS
except SEMSF13



Black ink jet printer mod. U2011: moving version for trays in fixed position. **26**

AVAILABLE ON:

ALL SEEDING LINES



Automatic stacker with discharge on the free roller belt, length up to 2000 mm. **27**

AVAILABLE ON:

ALL SEEDING LINES AND SEEDERS
except SEMSF13



Automatic stacker with discharge on variable length belt for high productivity. **28**

AVAILABLE ON:

ALL SEEDING LINES AND SEEDERS
except SEMSF13



Fast and self-centering system for width adjustment of the trays with handles. **29**

AVAILABLE ON:

BETA65C, LAMBDA65C,
YPSILON65C, KAPPA65C,
SEMLAMBDA65, SEMYPSILON65,
SEMBLOCK, SEMKAPPA65



Aluminium seeding plate with seed drop drawer with pneumatic opening. **30**

AVAILABLE ON:

SEMBLOCK

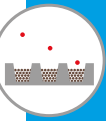

31

Soil feeding of the covering unit.

AVAILABLE ON:

SIGMA80, ALFA65, BETA65, LAMBDA65, YPSILON65

32

Double sowing drum.

AVAILABLE ON:

SIGMA80, ALFA65, BETA65/65C, LAMBDA65/65C, SEMBETA65, SEMLAMBDA65

33

Automatic recycling of the soil covering unit.

AVAILABLE ON:

SIGMA80, ALFA65, BETA65, LAMBDA65, YPSILON65

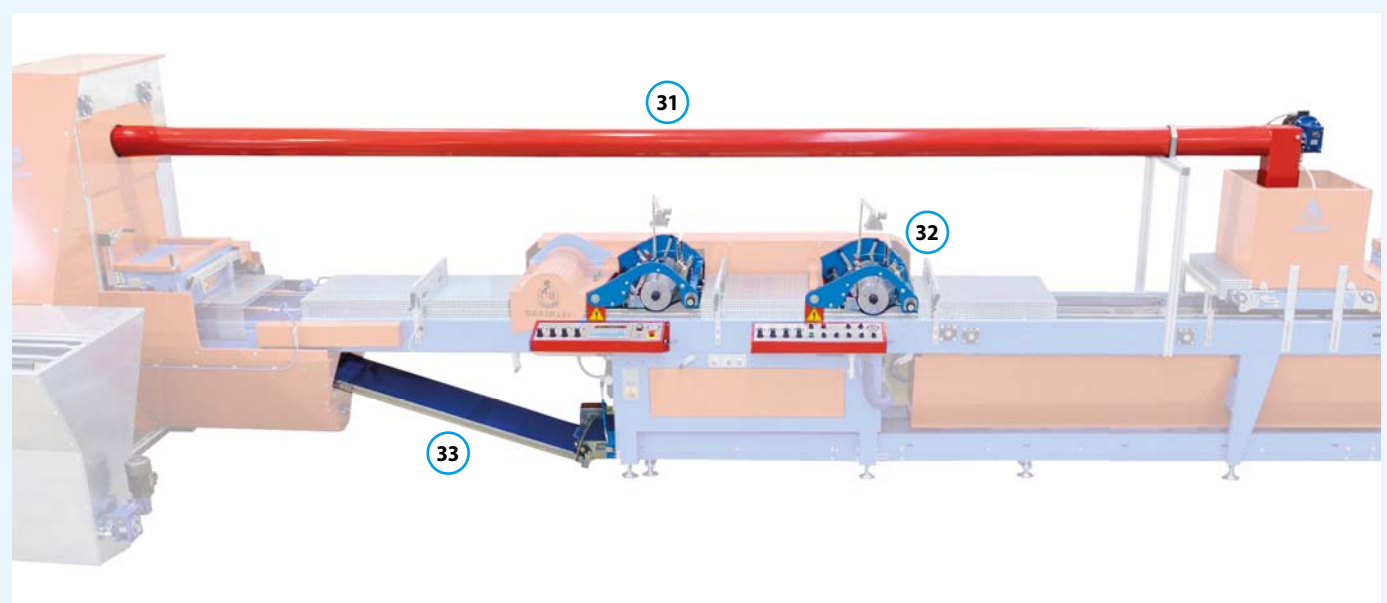

34

Frame completely made of stainless steel AISI304.

AVAILABLE ON:

ALL SEEDING LINES AND SEEDERS *except* SEMSF13

35

Seeding line with angular placing complete with transplanting belts. The U shape can also be selected.

AVAILABLE ON:

ALL SEEDING LINES

