

TECHNICAL SPECIFICATIONS

- 1 Seed loading from above.
- 2 Control with PLC and 5,7" colour touch-screen display.
 - Working height 700 mm.
 - Seed drop height adjustable up to 100 mm.
 - It stores up to 99 programs.
 - Multiseeding function.
 - Available in left and right version.

page 38-39

DETAILS

page 40-43

ACCESSORIES

- 11 17 18 20 21 22 23 25 27 28 29 30 34

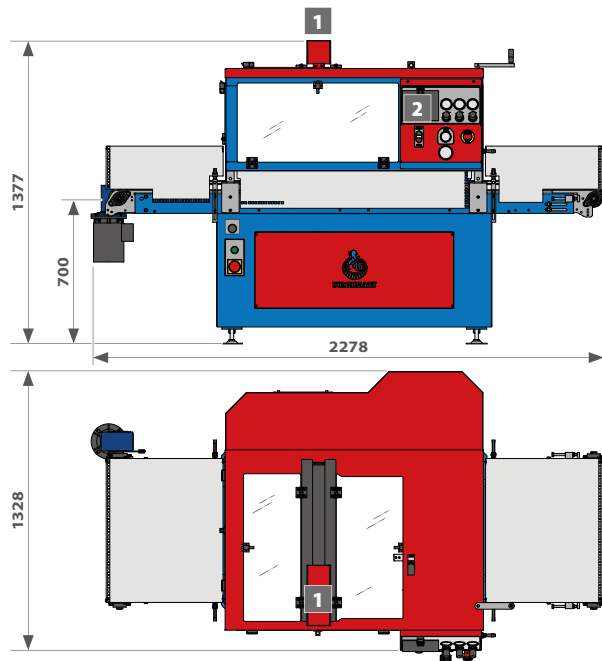

MACHINE DESCRIPTION

The SEMBLOCK plate seeder is recommended to sow in crates with preformed blocks. The plate vertical movement allows centering the seed in the block dibbler.

The belt advancement system enables to connect it to any other machine.

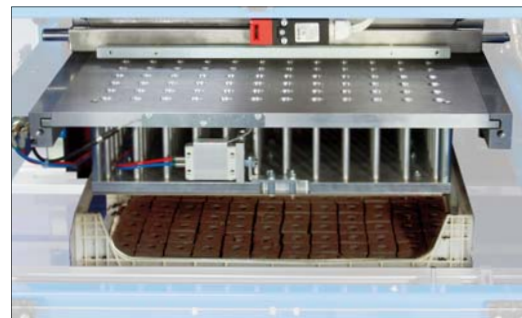

TECHNICAL DATA	M.U.	SEMBLOCK
HOURLY PRODUCTION (min-max)	crates/hour	800
TRAYS DIMENSIONS (max)	mm	600x400x150
CRATES DIMENSIONS (max)	mm	630x430x150
WEIGHT	kg	320
VACUUM PUMP	model	PVA 1300
AIR CONSUMPTION (max)	l/min	150
INSTALLED POWER	kW	5

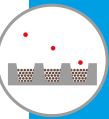

SEMBLOCK
DRUM seeder with plate - up to 800 crates/hour



URBINATI

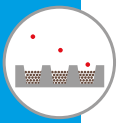

DETAILS

SEEDING



Ergonomic panel for an easy control of all machine's functions.

INCLUDED ON:

ALL SEEDING LINES



Colour touch-screen with intuitive graphic easy to use for the operator.

INCLUDED ON:

ALL SEEDING LINES

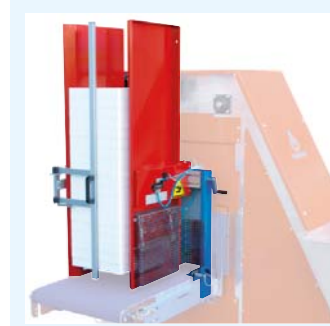

Tray denester **with 2 movements**, adjustable with one single handle.

INCLUDED ON:

ALL SEEDING LINES

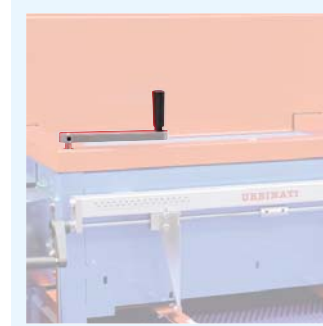

The adjustment of the tray's height, width and soil density is made with **functional handles**.

INCLUDED ON:

ALL SEEDING LINES

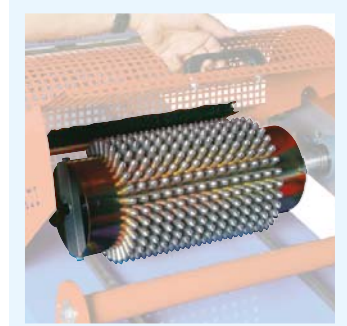

Driven dibbler with cleaning brush.

INCLUDED ON:

SIGMA80, ALFA65, BETA65/65C, LAMBDA65/65C, YPSILON65/65C



Double blow bar with more holes for the **seeding singulation**.

INCLUDED ON:

SIGMA80, ALFA65, BETA65/65C, LAMBDA65/65C, YPSILON65/65C



Easy and fast adjustment of seeding system's height and dibbler's depth, thanks to **comfortable handles**.

INCLUDED ON:

SIGMA80, ALFA65, BETA65/65C, YPSILON65/65C, KAPPA65C

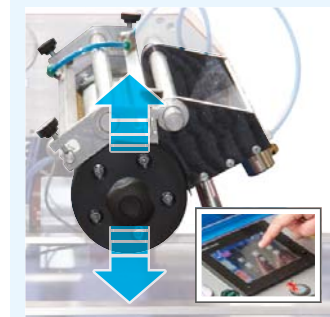

Electric adjustment of the drums' height with touch-screen.

INCLUDED ON:

LAMBDA65/65C



Adjustable speed hammers. The vibration helps placing the seeds in the center of the holes.

INCLUDED ON:

SIGMA80, ALFA65, BETA65/65C

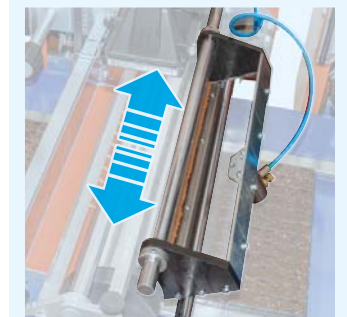

Oscillating seed holding plate to distribute the seeds **uniformly** all over the working width. It enables to work also with a small quantity of seed.

INCLUDED ON:

SIGMA80, ALFA65, BETA65/65C, LAMBDA65/65C, YPSILON65/65C

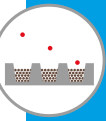

Thanks to the **modularity of the design**, our seeding lines and seeders **share common parts**.
The following pictures show some of the **most significant details**.

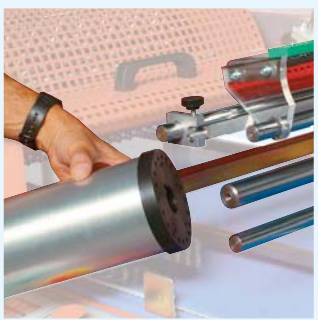

Fast and easy changing of the drum without any tool.

INCLUDED ON:

SIGMA80, ALFA65, BETA65/65C, LAMBDA65/65C, YPSILON65/65C



High-power vacuum pump: enables to use the same drum for the variety sowing of different weight.

INCLUDED ON:

SIGMA80, ALFA65, BETA65/65C, LAMBDA65/65C, YPSILON65/65C

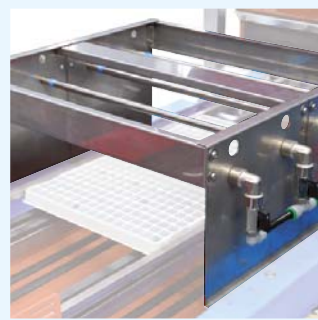

The drilled bar system, produced by CNC machines, makes the **watering uniform**.

INCLUDED ON:

ALL SEEDING LINES

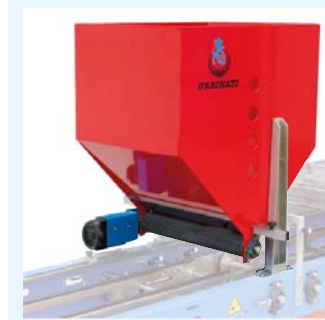

Drum vermiculite coverer: guarantees the best uniformity with all the granulometries.

INCLUDED ON:

ALL SEEDING LINES

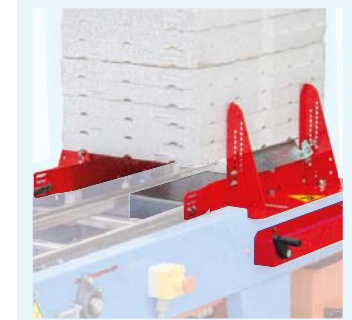

Easy and functional **balance stacker**.

INCLUDED ON:

ALL SEEDING LINES



Fast and self-centering system for width adjustment of the trays with handles.

INCLUDED ON:

SIGMA80, ALFA65, BETA65, LAMBDA65, YPSILON65

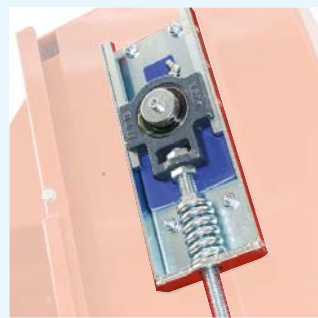

Engineering solutions aimed to reduce and simplify the maintenance. For example, visible bearings lubricator, spring tensioner on chains, etc.

INCLUDED ON:

ALL SEEDING LINES



Strong manufacturing and lasting materials, for example stainless steel and hot galvanizing for parts in contact with soil and water.

INCLUDED ON:

ALL SEEDING LINES



Seeding plate on sliding guides for a **fast change**.

INCLUDED ON:

SEMBLOCK



URBINATI

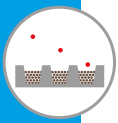

ACCESSORIES

SEEDING

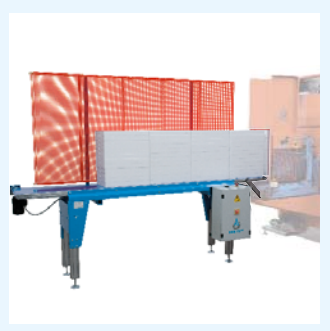

1
Feeding belt for single trays or empty stacks for denester.
L = 3300/4300/5300/6300 mm.

AVAILABLE ON:
ALL SEEDING LINES



2
Denester for heavy plastic trays at injection in polypropylene PP.

AVAILABLE ON:
ALL SEEDING LINES

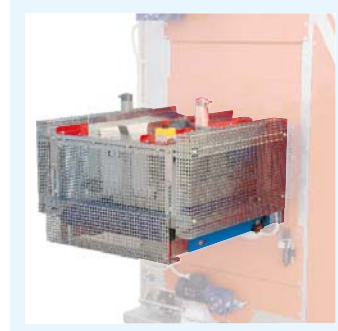

3
Electropneumatic denester with 3 movements for thermoformed trays (PE - PET).

AVAILABLE ON:
ALL SEEDING LINES

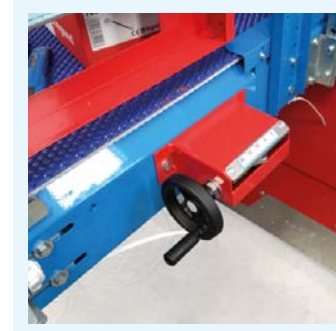

4
Adjustment device for trays with legs.

AVAILABLE ON:
ALFA65, BETA65/65C,
LAMBDA65/65C, YPSILON65/65C,
KAPPA65C

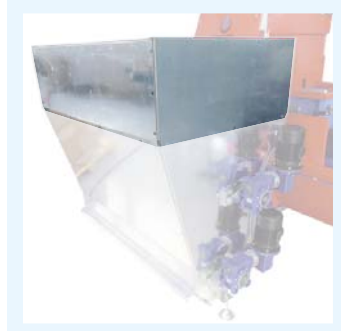

5
Peat hopper extension of 900 l.

AVAILABLE ON:
SIGMA80, ALFA65, BETA65,
LAMBDA65, YPSILON65



6
Flat dibbler for seeding of aromatic plants and multiseeding.

AVAILABLE ON:
ALL SEEDING LINES AND SEEDERS
with drum seeding system



7
Oscillating cleaning brush for the dibbler, useful with wet soil.

AVAILABLE ON:
SIGMA80, ALFA65, BETA65/65C,
SEMBETA65

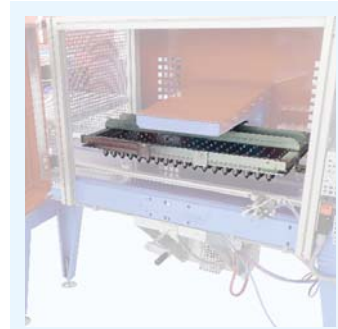

8
Plate dibbler mod. NI for depth bigger than 20 mm and for seeders assembled with nr. 3 sowing drums.

AVAILABLE ON:
LAMBDA65/65C, SEMLAMBDA65



9
Complete drum seeding kit: it includes one dibbler, one seeding drum and two nozzle bars.

AVAILABLE ON:
SIGMA80, ALFA65, BETA65/65C,
LAMBDA65/65C, YPSILON65/65C,
SEMBETA65, SEMLAMBDA65,
SEMYSILON65



10
Seeding bar kit: it includes one nozzle bar, one tube descent bar and one dibbler bar.

AVAILABLE ON:
KAPPA65C, SEMKAPP65, SEMSF13

These accessories **improve further the performance** and the productivity of our seeding lines and seeders. Our **engineering dept.** is at your disposal **to suggest the best solutions** for your needs.

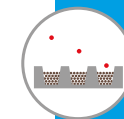

11 Sowing drum with **multi-hole nozzles** for aromatics, microgreens etc.

AVAILABLE ON:

SIGMA80, ALFA65, BETA65/65C, LAMBDA65/65C, YPSILON65/65C, SEMBETA65, SEMLAMBDA65, SEMYPSILON65, SEMBLOCK

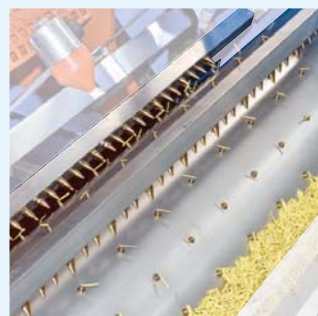

12 Seeding drum with **raised nozzles** for difficult seeds, for example tagetes, zinnia, etc.

AVAILABLE ON:

LAMBDA65/65C, YPSILON65/65C, SEMLAMBDA65, SEMYPSILON65



13 Air bars with labyrinths suitable to work with **big seeds**.

AVAILABLE ON:

SIGMA80, ALFA65, BETA65/65C, LAMBDA65/65C, YPSILON65/65C, SEMBETA65, SEMLAMBDA65, SEMYPSILON65



14 Drum for **big seeds**, as for ex. acorns.

AVAILABLE ON:

ALFA65, BETA65/65C, SEMBETA65

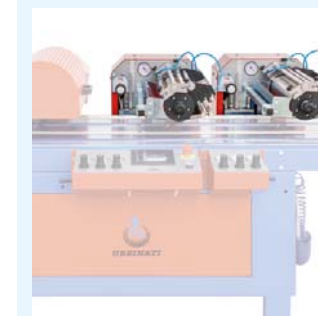

15 **Second/third sowing drum.**

AVAILABLE ON:

Second drum: SIGMA80, ALFA65, BETA65/65C, SEMBETA65
Second/third drum: LAMBDA65/65C, SEMLAMBDA65



16 Belt for the **recycling soil** for trayfiller.

AVAILABLE ON:

BETA65C, LAMBDA65C, YPSILON65C, KAPPA65C



17 **Seed inspection** to easily check the sown trays.

AVAILABLE ON:

ALL SEEDING LINES AND SEEDERS AND *except* SEMSF13



18 **Sand and soil coverer** with brush to clean the trays.

AVAILABLE ON:

ALL SEEDING LINES AND SEEDERS *except* SEMSF13

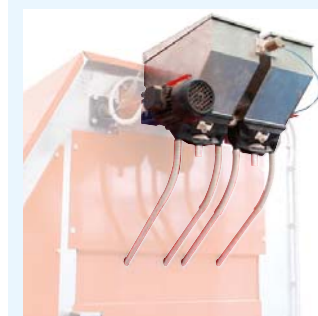

19 Fertilizer **distributor.**

AVAILABLE ON:

SIGMA80, ALFA65, BETA65, LAMBDA65, YPSILON65



20 **Loading and automatic recycling** of vermiculite with hopper capacity 240 l.

AVAILABLE ON:

ALL SEEDING LINES AND SEEDERS *except* SEMSF13



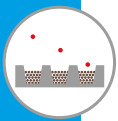

ACCESSORIES

SEEDING



Soil recycle, to recover the exceeding soil. **21**

AVAILABLE ON:

ALL SEEDING LINES AND SEEDERS
except SEMSF13



Triget watering unit: on request as alternative to the watering unit with drilled bars. **22**

AVAILABLE ON:

ALL SEEDING LINES AND SEEDERS
except SEMSF13

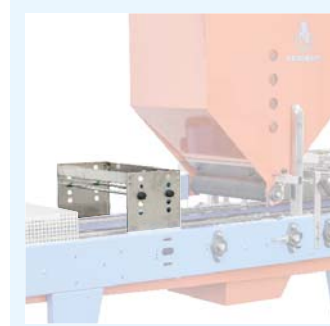

Second water unit with nr. 2 drilled bars: mainly needed to increase the soil watering. **23**

AVAILABLE ON:

ALL SEEDING LINES AND SEEDERS
except SEMSF13



ETC automatic labelling machine: to print and apply labels on the trays coming out from the denester. **24**

AVAILABLE ON:

ALL SEEDING LINES



Black ink jet printer mod. U2011: fixed version for moving trays to write on the long side of the tray. **25**

AVAILABLE ON:

ALL SEEDING LINES AND SEEDERS
except SEMSF13



Black ink jet printer mod. U2011: moving version for trays in fixed position. **26**

AVAILABLE ON:

ALL SEEDING LINES

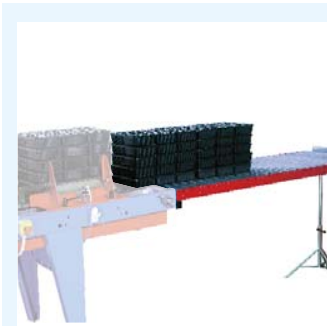

Automatic stacker with discharge on the free roller belt, length up to 2000 mm. **27**

AVAILABLE ON:

ALL SEEDING LINES AND SEEDERS
except SEMSF13



Automatic stacker with discharge on variable length belt for high productivity. **28**

AVAILABLE ON:

ALL SEEDING LINES AND SEEDERS
except SEMSF13



Fast and self-centering system for width adjustment of the trays with handles. **29**

AVAILABLE ON:

BETA65C, LAMBDA65C,
YPSILON65C, KAPPA65C,
SEMLAMBDA65, SEMYPSILON65,
SEMBLOCK, SEMKAPPA65



Aluminium seeding plate with seed drop drawer with pneumatic opening. **30**

AVAILABLE ON:

SEMBLOCK

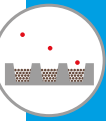

31

Soil feeding of the covering unit.

AVAILABLE ON:

SIGMA80, ALFA65, BETA65, LAMBDA65, YPSILON65

32

Double sowing drum.

AVAILABLE ON:

SIGMA80, ALFA65, BETA65/65C, LAMBDA65/65C, SEMBETA65, SEMLAMBDA65

33

Automatic recycling of the soil covering unit.

AVAILABLE ON:

SIGMA80, ALFA65, BETA65, LAMBDA65, YPSILON65

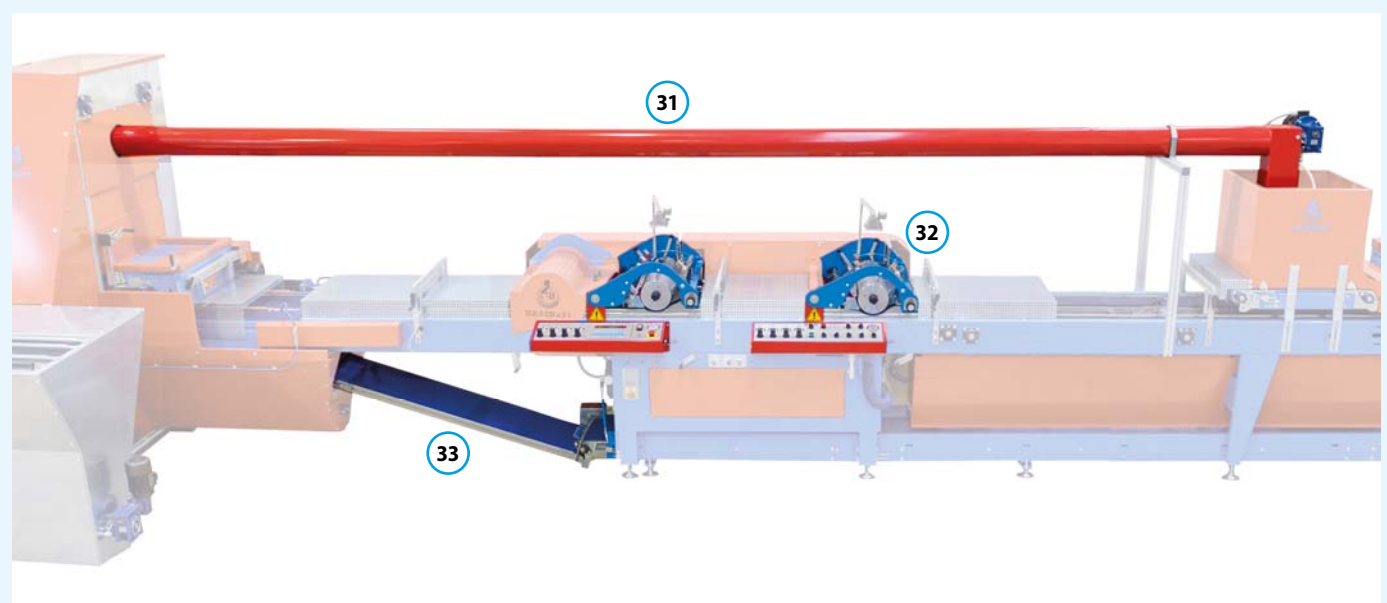

34

Frame completely made of stainless steel AISI304.

AVAILABLE ON:

ALL SEEDING LINES AND SEEDERS *except* SEMSF13

35

Seeding line with angular placing complete with transplanting belts. The U shape can also be selected.

AVAILABLE ON:
ALL SEEDING LINES

